

Installation, use and maintenance manual

ZEN 100
12/24 V dc



CE

INDEX

1. LAYOUT OF MANUAL.....	3
1.1 STRUCTURE OF THE MANUAL	3
1.2 DESCRIPTION OF THE PICTOGRAMS.....	3
2. GENERAL WARNINGS AND INFORMATION TO THE RECIPIENT	4
2.1 IMPORTANT INFORMATION	4
2.2 SAFETY WARNINGS	4
2.3 WARRANTY.....	5
2.4 IDENTIFICATION OF THE UNIT	6
2.5 LEGISLATIVE REFERENCE	6
2.5.1 DIRECTIVES AND STANDARDS CONCERNING MACHINE SAFETY.....	6
2.5.2 RESPECT FOR THE ENVIRONMENT – REQUIREMENTS FOR REMOVAL AND DISPOSAL.....	6
3. PRODUCT PRESENTATION	8
3.1 TRANSPORT AND MATERIAL HANDLING	8
3.2 STOCK.....	9
3.3 PACKAGING.....	9
3.3.1 PACKAGING CONTENTS.....	9
3.4 ATTACHED DOCUMENTS	10
3.5 TECHNICAL DATA	10
3.6 FEATURES OF THE PRODUCT	11
3.7 ADVANTAGES OF THE ENERGY RECOVERY SYSTEM	12
3.8 COMPOSITION OF THE MACHINE	13
3.8.1 PUMP GROUP.....	13
3.8.2 WATERMAKER GROUP.....	14
3.8.3 ACCESSORIES	16
4. MOUNTING AND INSTALLATION.....	17
4.1 GENERAL CRITERIA	17
4.2 COMPONENTS MOUNTINGS	18
4.2.1 PUMP GROUP.....	18
4.2.2 WATERMAKER GROUP	18
4.2.3 ACCESSORIES.....	21
4.3 INSTALLATION	21
4.3.1 WATER INTAKE AND DISCHARGE.....	21
4.3.2 SEAWATER INTAKE.....	21
4.3.3 FRESH WATER CONNECTION FOR FLUSHING	22
4.3.4 BRINE DISCHARGE	22
4.4 HYDRAULIC CONNECTIONS	23
4.5 ELECTRIC CONNECTIONS.....	26
4.5.1 REMOTE CONTROL PANEL MOUNTING	26
4.5.2 ELECTRIC CONNECTIONS: WIRES (ZEN 100 12/24V DC).....	26
5. FUNCTIONING AND USE.....	28
5.1 COMMAND DESCRIPTION.....	28
5.1.1 ALARMS DESCRIPTION	28
5.2 FIRST START UP PROCEDURE.....	28
5.2.1 PRELIMINARY CHECKS BEFORE PROCEEDING WITH THE START-UP PROCEDURE	29
5.2.2 START-UP.....	29
5.3 NORMAL OPERATING PROCEDURE	30

5.3.1	NORMAL OPERATING PROCEDURE WITHOUT FINAL FLUSHING	30
5.3.2	NORMAL OPERATING PROCEDURE WITH FINAL FLUSHING (RECOMMENDED PROCEDURE)	31
5.3.3	WORKING CYCLE WITH TIMER	31
5.3.4	LONG FLUSHING PROCEDURE.....	31
5.4	RESET PROCEDURE	32
6.	MAINTENANCE (ROUTINE AND SPECIAL).....	34
6.1	CHECK FILTER CLEANLINESS	34
6.2	CHECK THE PLANT WORKING PRESSURE	35
6.3	CHECK FOR LEAKS.....	35
6.4	CHECK FOR MEMBRANES REPLACEMENT	35
6.5	SHUTDOWN PROCEDURE	35
6.5.1	NECESSARY EQUIPMENT	36
6.5.2	SHUTDOWN OPERATING PROCEDURE.....	37
6.6	ANTIFREEZE PROCEDURE (WINTERIZING PROCEDURE IN COLD CLIMATE - UNDER 5°C).....	39
6.7	PERIODIC MAINTENANCE.....	40
6.7.1	MEMBRANE REPLACEMENT.....	40
6.8	ADJUSTMENTS	40
7.	TROUBLESHOOTING.....	41
7.1	TROUBLESHOOTING CHART.....	41
8.	SUGGESTED SPARE PARTS.....	42
8.1	SHORT TERM CRUISING.....	42
8.2	LONG TERM CRUISING	42

1. LAYOUT OF MANUAL

1.1 Structure of the manual

The manual is divided into chapters, which gather all the information necessary to use the system without risk. Within each chapter there is a subdivision in paragraphs to focus on essential points; each paragraph can be found with a subtitle and a description.

At the top of each page the heading section is to remind the reader of the scope of the page.

Within the chapter, for example chapter 1, we will have:

1	Chapter title
1.1	Paragraph title
1.1.1	Subtitle
1.1.1.1	Further subtitles

The numbering of the figures and tables, is reset to each chapter; therefore, we will find the prefix indicating the chapter and the page number, figure or table in progressive that starts from number 1 at the beginning of each chapter.

1.2 Description of the pictograms

The following symbols will be used in the manual to highlight important indications and warnings:



ATTENTION:

This symbol indicates accident prevention regulations for the operator and / or for any exposed persons.



CAUTION:

This symbol indicates that there is the possibility of damaging the system and / or its components.



NOTE:

This symbol indicates useful information.

2. GENERAL WARNINGS AND INFORMATION TO THE RECIPIENT

2.1 Important information

To safeguard the operator's safety and to avoid possible damage to the machine, before carrying out any operation on the machine, it is essential to read carefully all the instructions manual.

This manual must be complete and legible in its entirety, every operator involved in the use of the machine, or responsible for maintenance or adjustment operations, must know its location and must have the possibility to consult it at any time.

All rights of reproduction of this manual are reserved to SCHENKER ITALIA. This manual cannot be transferred to third parties without the written authorization of SCHENKER ITALIA.

The text cannot be used in other printed matter without the written permission of SCHENKER ITALIA.

The descriptions and illustrations provided in this publication are not binding.

SCHENKER ITALIA reserves the right to make any modifications it deems appropriate.

© SCHENKER ITALIA

THIS MANUAL IS PROPERTY OF SCHENKER ITALIA, ANY REPRODUCTION, EVEN PARTIAL, IS PROHIBITED.

This manual was drafted according to the requirements of the 2006/42 / EC Machinery Directive.

2.2 Safety warnings

- Wear protective equipment suitable for service operation.
- Clothing must be tight to the body, and resistant to the products used for cleaning.
- Do not remove safety devices or accident prevention protection.
- To check if the plant is correctly installed contact a Schenker service point.
- Verify that the electric and hydraulic connections are in keeping with the indicated specifications.
- Avoid using the plant if the sea water is polluted.
- Children and inexperienced people shall not touch or operate the plant.
- Check periodically that no leaks are present. Avoid installing the plant where a leak may cause damage and/or jeopardize the safety of the vessel.
- Maintenance should only be carried out by suitably qualified persons or Schenker personnel.



ATTENTION

Any technical changes or operating conditions indicated that affect the correct operation or safety of the machine must only be carried out by the manufacturer's technical staff or by technicians formally authorized by the manufacturer. Otherwise, SCHENKER ITALIA declines any responsibility for changes or damages that may result from it.

2.3 Warranty

The equipment and the relevant accessories are guaranteed 12 months from delivery. The guarantee does not include consumable items (filters, carbon filters, membranes, etc.). The "ERS" pressure amplification device is guaranteed 36 months, provided that the annual maintenance is performed at a Schenker service point.

The guarantee covers faults, defect of materials and parts. It is limited to the replacement or re-pair of faulty parts. The expense for the disconnecting and reinstalling on the vessel and transport of the equipment from or to our Service Point, or our factory will be at the customers own expense.

The under guarantee delivered parts transport, will be at customer's own risk.

In case of repairs under guarantee performed by our technicians on the customer's vessel, the faulty parts replacement cost will be at Schenker's expense, while manpower and travel expenses will be charged to the customer. The guarantee does not include faults caused by negligence in operating, maintenance and installation of the device (if not carried out by an authorised Schenker Service point).

Dismantling by non-authorized personnel will render void all guarantees. Schenker Italia cannot be held liable for any direct or indirect damage caused by the malfunctioning equipment, limiting its responsibility to the repair and replacement of faulty parts.



ATTENTION

SCHENKER ITALIA declines any responsibility for improper use of the machine, for damages caused as a result of operations not covered by this manual or unreasonable use.

2.4 Identification of the unit

The Zen can be identified through a serial number printed on the left flange of the unit.



Serial number
Fig. 2-1

2.5 Legislative reference

2.5.1 Directives and standards concerning machine safety

- Machinery Directive 2006/42 / EC, in force since December 29, 2009;
- Low Voltage Directive 73/23 / EEC and subsequent amendments and additions: 93/68 / CEE implemented by the Law of 18 October 1997 n. 791.
- Electromagnetic Compatibility Directive 89/336 / EEC and subsequent amendments and additions: 93/31 / CEE implemented with D.L. December 4, 1992 n. 476.
- Standards UNI EN 292/1 and 292/2 (safety of machinery);

2.5.2 Respect for the environment – requirements for removal and disposal



ATTENTION

Removal and disposal of materials, as result of the decommissioning of the machine, must be performed in accordance with the regulations in force, for the safeguard and protection of the environment.

With regard to removal and disposal, it should be noted that the materials of which the machine is made of are not of a dangerous nature and consist essentially of:

- Stainless Steel;
- Plastic;
- Carbon fibre;
- Motors, cables and consumable electrical materials;

- Rubber and polyurethane seals.

After dismantling the machine, the various materials must be segregated according to the regulations of the country in which the machine has been removed.

The machine does not contain dangerous components or substances that require special removal procedures.



ATTENTION

Different legislations are in force in the different countries, therefore the prescriptions imposed by the laws and by the agencies designated by the Countries must be observed.

3. PRODUCT PRESENTATION



ATTENTION

Be sure to follow general safety instructions.

- Wear protective equipment suitable for the transport and handling operations.
- Lift the machines with equipment appropriate to the weight and size of the box, taking the utmost care and following carefully the instructions on the present use and maintenance manual (attachment points for loading devices, etc.).
- Make sure that the lifting equipment used is in good condition and correctly maintained.
- Do not stand or pass under the groups to be moved during lifting or transport operation.

3.1 Transport and material handling

The watermaker unit is transported in a cardboard box. In the following table dimension and weight are indicated.

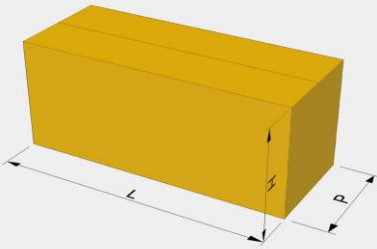

MATERIALS HANDLING
fig. 3-1

	Model	L cm.	W cm.	H cm.	Weight Kg.
	Zen 100	82	64	47	75

Packaging dimensions and weight
tab.3-1

3.2 Stock



ATTENTION

To avoid damage to the system, store the unit in a dry place at a temperature of between 5°C and 45°C. Very cold temperatures could lead to a freezing of the fluid inside the system with the consequence of a permanent damage of the system.

3.3 Packaging

3.3.1 Packaging contents



PACKAGING (picture for purely information)
FIG. 3-2

ZEN 100	
Watermaker	Pump group
Active carbon filter with electrovalve	5 microns filter with accumulator
Mesh filter	Non-return valve with Tee fitting
Remote panel	10 mt extension cable for remote panel
Installation kit	Filter key
6x8 hose for production	

3.4 Attached documents

The packaging contains the technical documentation (use and maintenance manual, electric and hydraulic scheme, warnings and instructions).



ATTENTION

- Read carefully the use and maintenance manual before installing the system.
- Use only recommended material for the installation (especially hoses, fittings and seals) in accordance with the manual.
- Do not store the unit under temperature below 5°C and above 45 °C



DOCUMENTS INCLUDED IN THE PACKAGING (picture for purely information)
FIG. 3-3

3.5 Technical data

WATERMAKER

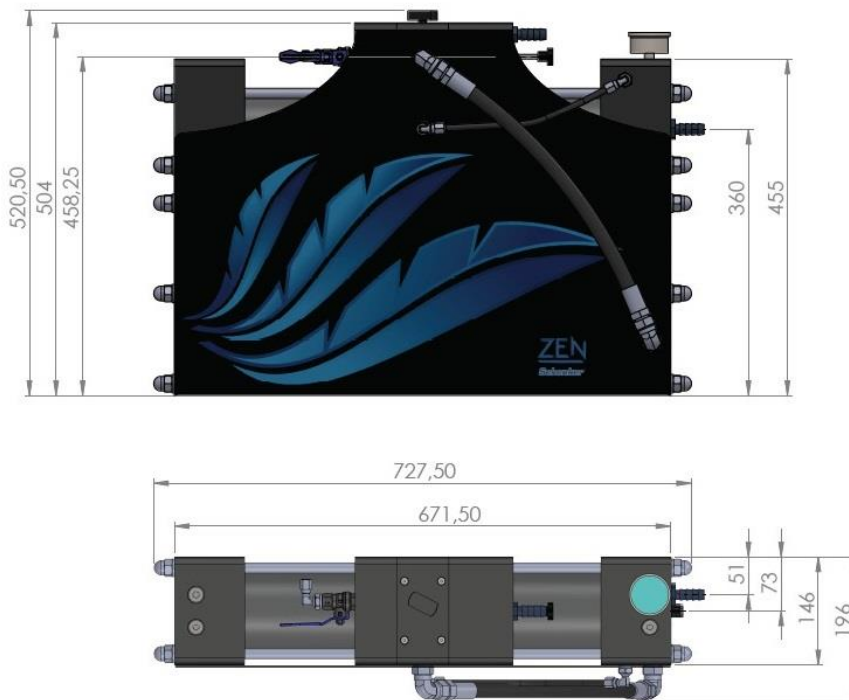

WATERMAKER DIMENSIONS
FIG. 3-4

Weight 37. Kg (empty)

Hydraulic Connection

Seawater inlet: hose barb for 20mm internal diameter reinforced hose.
Brine Discharge: hose barb for 16mm internal diameter reinforced hose.
Fresh water: ¼" fitting, 6x8mm hose.

PUMP

Dimensions

Length: 37 cm
Width: 15 cm
Height: 23 cm
Weight: 11 Kg

Hydraulic Connection

Water inlet: hose barb for 20mm internal diameter reinforced hose.
Water outlet: hose barb for 16mm internal diameter reinforced hose.

Feed pump type: Rotative pump

Filters: n. 1 Cartridge filter 5 microns 2.32" x 9 ¾"
n. 1 Active carbon filter 2.32" x 9 ¾"

Power supply: 12 VDC +/- 15% (100Z12 version)
24 VDC +/- 15% (100Z24 version)

Average electric consumption: 400 Watt/h average

Peak electric consumption: 800 Watt

Nominal fresh water production: 100 Lit/h +/- 20% @ seawater 25 °C salinity 35.000 ppm

Fresh water quality: Under 500 ppm TDS average

CEE conformity: In compliance with directives 89/392 CEE sect.1 (general safety machines requirements), 89/336 CEE (electromagnetic compatibility), 73/23 CEE (electric safety requirements)

3.6 Features of the product

The water produced by a Schenker plant, produced from clean seawater has a purity of between 350 & 450 parts per million Totally dissolved solids (TDS/PPM), but the potability may not be guaranteed as bacterium may be present in the watermaker, caused by non-observance of shutdown and cleaning procedures. It is essential that correct shut down and storage procedures are followed to ensure continued purity of the product water. UV treatment of the product water may be beneficial.

3.7 Advantages of the Energy recovery system

Introduction

Thank you for choosing a Schenker Watermaker.

As all the equipment, the knowledge of operating and maintenance procedures allows to use the system in the best way, and to guarantee a perfect functioning throughout the years. We invite you to read carefully this manual and to keep it for a quick reference.

Functioning principles

The Schenker watermakers, as an alternative to the high-pressure pumps of traditional systems, utilizes the ENERGY RECOVERY SYSTEM patented device, which amplifies the pressure of common low-pressure pumps, and recoup all the hydraulic energy back from the membranes, allowing a high energy efficiency.

The lack of high-pressure pumps makes the system silent and vibration free, and enormously simplifies its use as no adjustment is necessary for its operating.

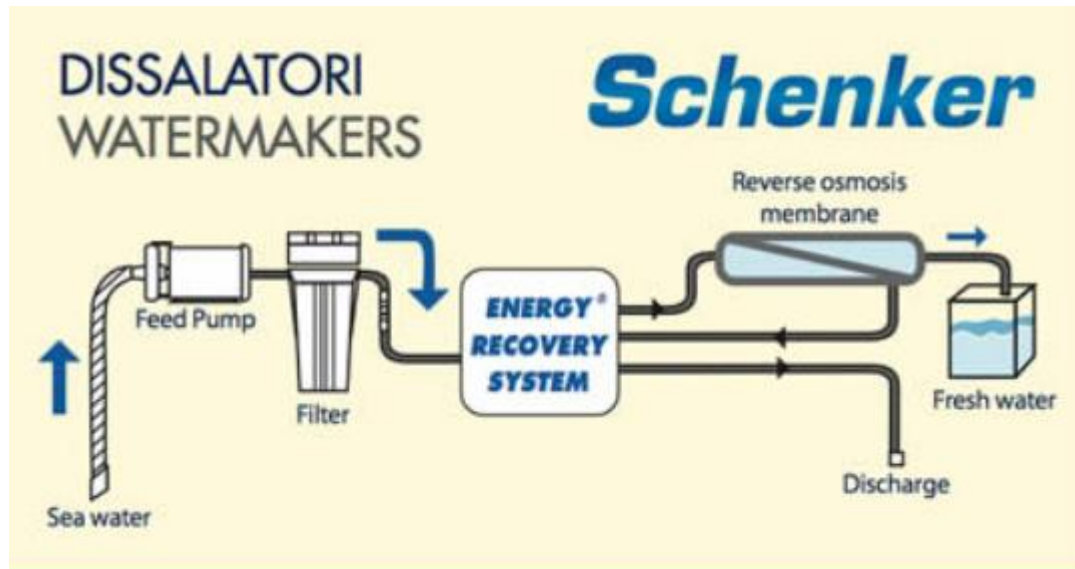

FUNCTIONING SCHEME
FIG. 3-5

3.8 Composition of the machine

The machine is composed of the following parts:

1. PUMP GROUP
2. WATERMAKER GROUP

3.8.1 Pump group

This pump picks up sea water and sends it to the watermaker group, through the pre-filter. The pump group is composed of the following components:

- 5 micron cartridge filter
- Pressure switches
- Pump box
- Accumulator

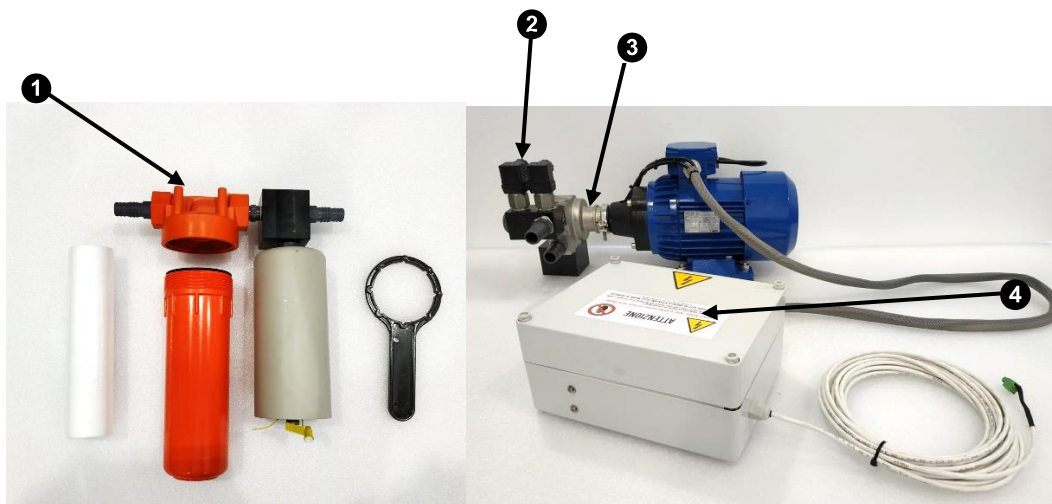

PUMP GROUP
FIG. 3-6

- | | |
|--|----------------------------|
| 1 5 micron filter + accumulator | 3 Pump head + motor |
| 2 Pressure switches | 4 Pump box |

High pressure switch. It is hydraulically connected to the pump. It stops the system if the pump pressure exceeds 13 bar. In this case a high-pressure alarm is activated on the control panel.

Low pressure switch. It is hydraulically connected to the pump. It stops the system if the pump pressure doesn't exceed 1,3 bar. In this case a low-pressure alarm is activated on the control panel.

Pump box. Plastic Box with all the electric connections for the power supply of motor, motherboard, pressure switches, remote panel and electrovalve.

Accumulator. This is a polypropylene air reservoir. Its function is to reduce and stabilize the pressure peaks during the watermaker functioning. The device has to be pre-charged with air through the Schrader valve. The pressure is about 6 Bar. The accumulator is preloaded in factory to the correct pressure.

3.8.2 Watermaker group

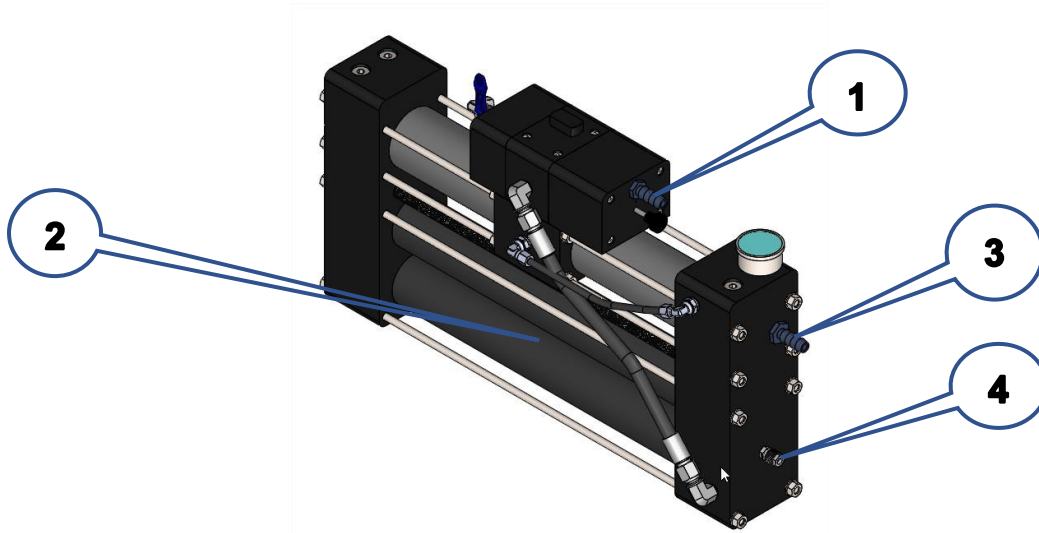

WATERMAKER GROUP (SIDE VIEW W/O COVER)
FIG. 3-7

- | | |
|-------------------------------|--------------------------|
| ① Watermaker outlet/discharge | ③ Watermaker inlet |
| ② Reverse osmosis membranes | ④ Fresh water production |

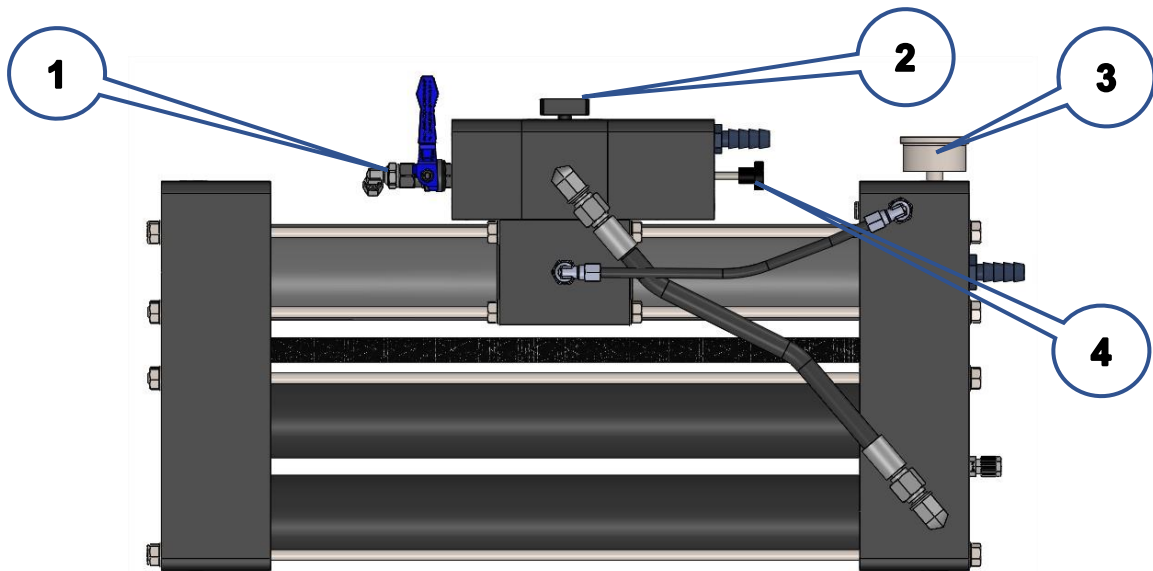

WATERMAKER GROUP (FRONT VIEW W/O COVER)
FIG. 3-8

- | | |
|--------------------------|-------------------|
| ① Reset valve | ③ Manometer |
| ② Depressurization valve | ④ Positioner knob |

The watermaker group is composed of the following parts:

- Reverse osmosis membranes
- Energy Recovery System
- Manometer
- Depressurization valve
- Positioner
- Reset valve

Reverse osmosis membranes. They are installed inside the carbon fibre high-pressure housing. Membranes are n.2 x SW4021 type. Their purpose is to separate the intake high-pressure seawater in two flows: one for the salt-water drain and one for the fresh water production.

Energy Recovery System. The heart of the system. It has the function of amplifying the pressure supplied by the pumps and to recoup the hydraulic energy back from the membranes. The ERS device makes periodic cycling by a hydraulically controlled automatic valve. The cycles are noticeable through a "beat" issued by the watermaker unit. The unit is based on cylinders and a central body containing the hydraulic valve necessary for the system to function.

Manometer. Located on the right side of the watermaker, it measures the working pressure of the watermaker.

Depressurization valve. It is used for the air bleeding of the unit. It is located on the top of the watermaker. Its function is to depressurize the system and to allow the bleeding of air. The valve must be closed during normal working conditions (completely screwed in) and it is opened during the air bleeding operations (slightly unscrewed).

Positioner. It is a stainless steel threaded arm, with a black knob, located on the right hand side of the watermaker. Its function is to reset the unit in case of hydraulic block.

Reset valve. It is installed on top of the ERS it is recognizable by the little blue lever. The valve must be closed during normal functioning (lever perpendicular to the valve). This valve has the function of allowing the resetting of the ERS in case of a system block. It must be opened before screwing in the valve positioner.

3.8.3 Accessories

The main accessories of the watermaker are the following:

- Active carbon filter
- Electrovalve
- Non-return valve
- Mesh filter (strainer)



ACCESSORIES
FIG. 3-9

- ① Non-return valve
- ② Mesh filter

- ③ Active carbon filter
- ④ Electrovalve

Active carbon filter. This filter is connected between the fresh water pressurized system of the boat and the electro valve on the filter holder. On the filter inlet is positioned a manual valve that allows replacement of the cartridge without depressurizing the fresh water system of the vessel.

Electrovalve. It has the function of switching from seawater intake to fresh water tank when washing the watermaker.

Non-return valve. It stops water flowing out of the inlet hose. **It must be installed vertically.** It stops leaking of fresh water from the seacock whilst the washing procedure commences.

Mesh filter. The machine is equipped with a mesh filter to protect the pump from macro sediments. This is placed between the seacock and the pump.

4. MOUNTING AND INSTALLATION

4.1 General criteria

Before commencing the installation, it is important to carefully plan all the activities, by evaluating all of the siting locations of the equipment. The main points to focus on are the following:

- Selecting of seawater inlet/outlet
- Positioning of the main units (pump group, watermaker group, active carbon filter).
- Positioning of the thermal-magnetic circuit breaker.
- Routing of the hoses and electric cables.



CAUTION

For a correct installation of the watermaker please follow the instructions below:

- *The through-hull fitting should be located in a central and low position on the hull, in the way that air can't be sucked in to the pump and subsequently the watermaker itself.*
- *The non-return valve has to be installed under seawater level and as close as possible to the through-hull fitting, in vertical position.*
- *The pump must be installed as low as possible in respect of the waterline and as close as possible to the seawater intake (through-hull fitting). No more than 2m away unless a positive feed is achieved by locating the pump below the waterline.*
- *The watermaker unit must be positioned and arranged on an adequate support which is able to sustain the weight (about 50 Kg). The max permitted room temperature must not exceed 40°C.*



CAUTION

The pump group must be installed in a ventilated place, in order to facilitate the cooling of the electric motor.



ATTENTION

The external surface of motor of the pump can reach high temperature; therefore, it is recommended to avoid possible contacts with inflammable liquids and materials.



NOTE

Once an installation plan has been made it is recommended to make a schematic drawing of the hydraulic and electric connections and attach them to the manual for future reference.

4.2 Components mounting

4.2.1 Pump group

The diaphragm pump group must be installed if possible below the waterline, and as close to the water inlet as possible (2m max).

The pump group should be installed in an adequately ventilated area, with the purpose of aiding the cooling of the motor. **The max permitted room temperature must not exceed 45°C.**

Avoid the contact or the proximity with inflammable material or liquid, since the motor surfaces can reach elevated temperatures. Avoid locating the pump wherever a possible loss of water can involve damages or jeopardize its safety. The pump must be installed on a base sufficiently horizontal, suitable to sustain the weight of the group. The pump is normally fixed on the support structure by passing bolts.

4.2.2 Watermaker group

Install the watermaker above the pump. **The max permitted room temperature must not exceed 40°C.** It can be placed either horizontally or vertically. **The watermaker must lie completely on a flat surface. The supplied rubber-based adhesive must absolutely be stuck to the supporting surface.** Once in place on the supporting surface, the watermaker must be fastened with the provided L-brackets. **In no way must the watermaker be suspended using solely the L-brackets but it must rest on a flat surface at all times. Otherwise a shelf is necessary as base to support the weight of the watermaker.**

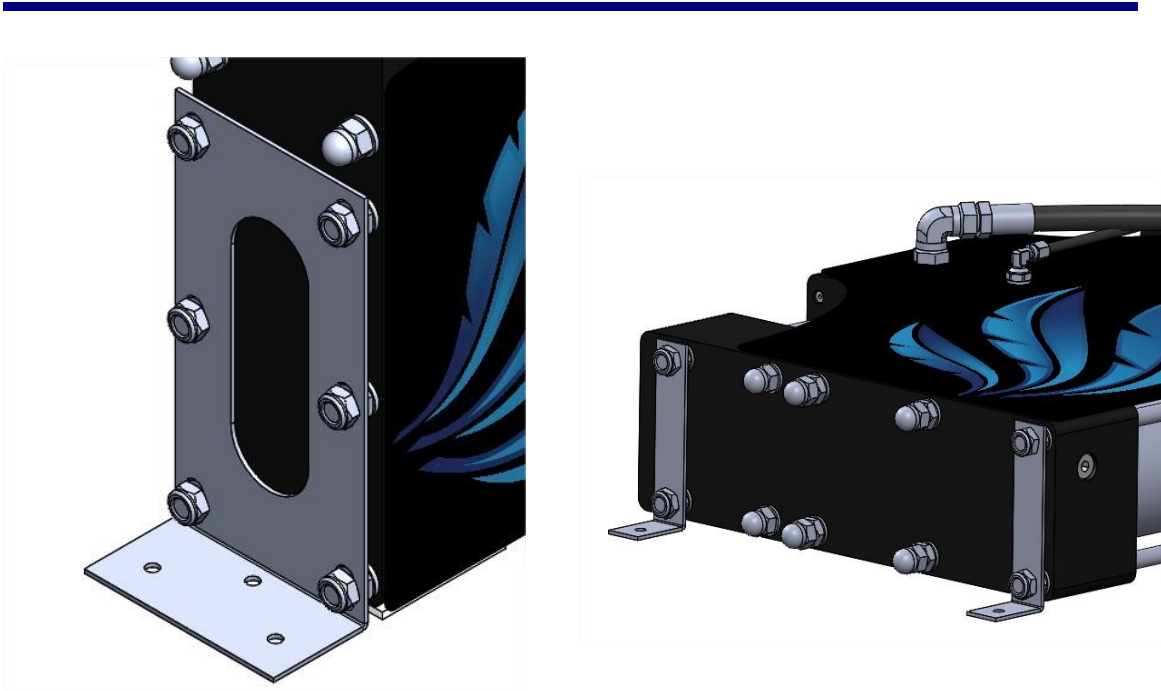

VERTICAL AND HORIZONTAL FIXING
FIG. 4-1

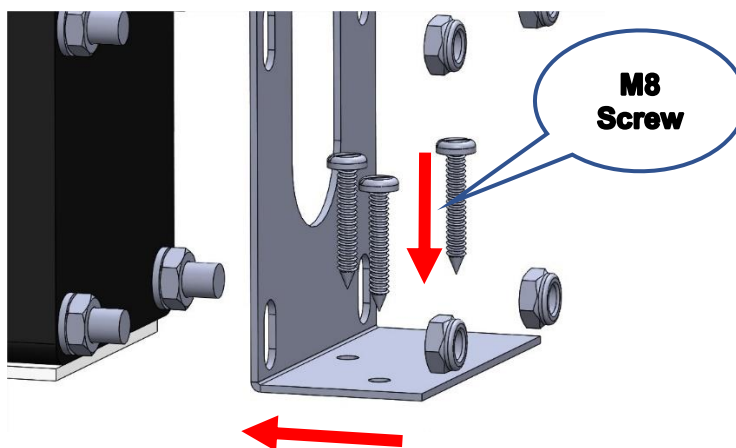

MOUNTING PROCEDURE
FIG. 4-2

ok

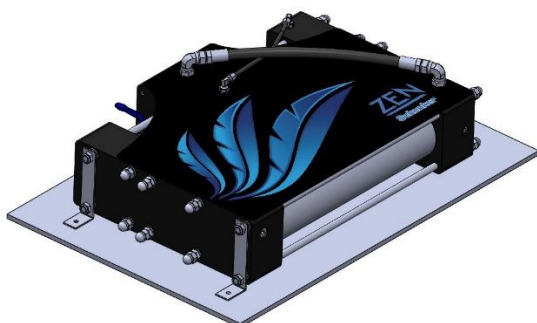

ok

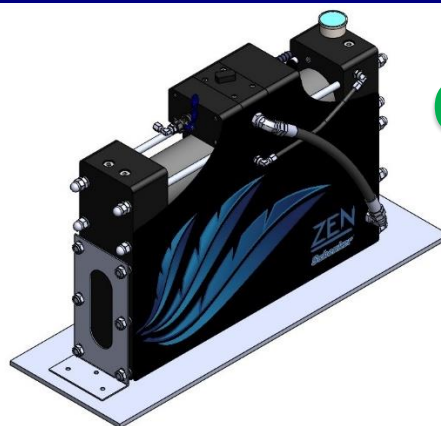

NO

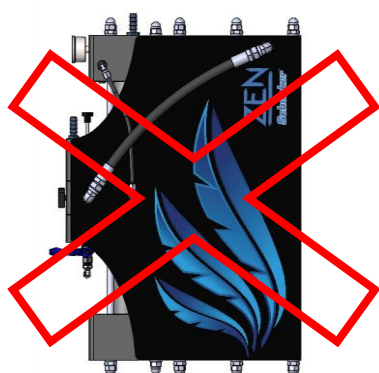

NO

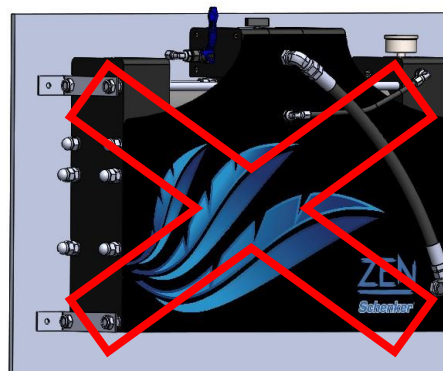

POSSIBLE CONFIGURATIONS
FIG. 4-3

For a complete installation, antivibration rubber stickers are provided.

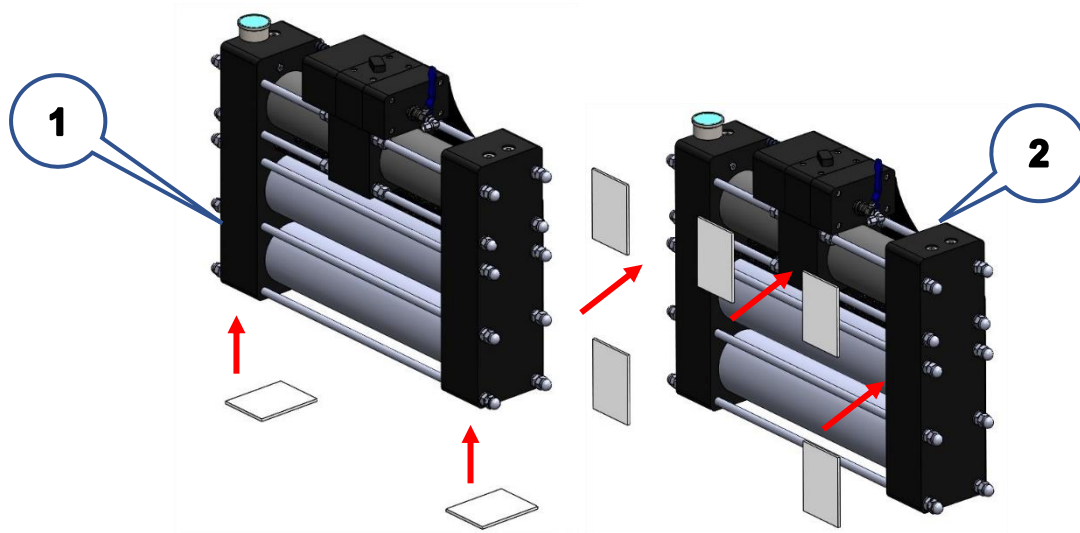

RUBBER STICKER POSITIONS
FIG. 4-4

❶ Vertical installation

❷ Horizontal installation



ATTENTION

Please follow the instruction to install the unit: an incorrect mounting could damage the lateral manifolds of the watermaker.

If the unit is installed horizontally it is recommended connect the manometer horizontally as well in order to be visible. This can be done making use of the fittings provided.

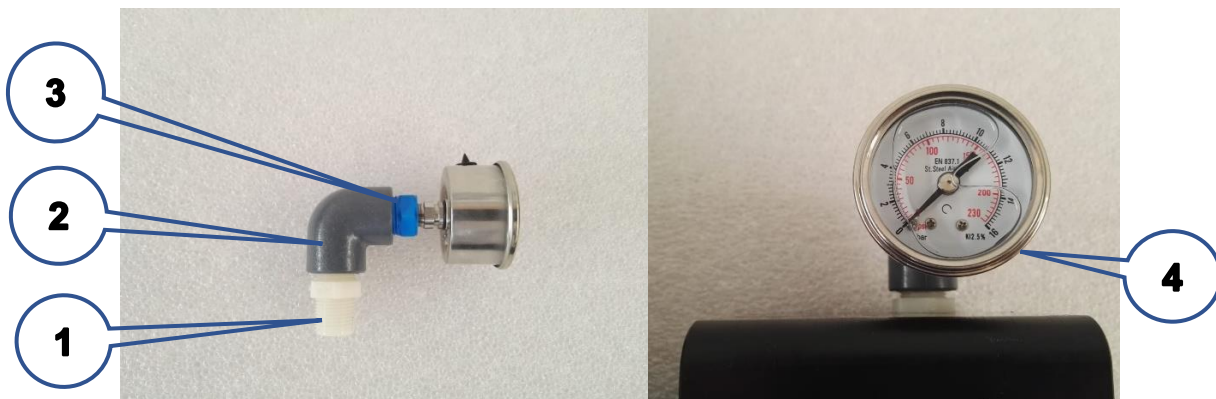

HORIZONTAL FIXING
FIG. 4-5

❶ 3/8" Nipple
❷ 3/8" 90°-Degree Elbow

❸ 3/8" male to 1/8" female reducer
❹ Manometer

There is a plug on the right side of the watermaker (1). This plug has to be removed with a key #27 and has to be replaced with a housebarb (2), provided with the installation kit. It could be installed with a key #24 until its mechanical stop. Don't exceed with the torque.

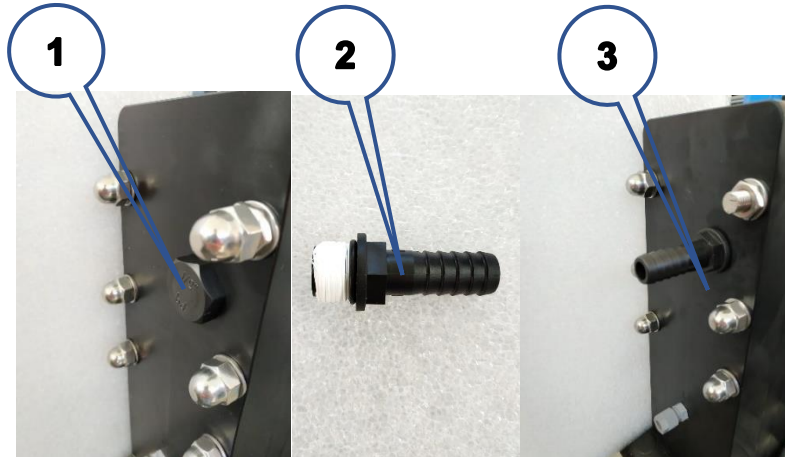

SEAWATER IN MOUNTING
FIG. 4-6

- 1** Plug
- 2** IN housebarb
- 3** Final mounting

4.2.3 Accessories

The non-return valve has to be installed vertically as close as possible to the seawater intake, following the direction of the arrow.

The active carbon filter (and the attached electrovalve) has to be placed next to the pump group, if possible, vertically and easily accessible.

4.3 Installation

4.3.1 Water intake and discharge

For a correct installation of the watermaker it is necessary to arrange the following water intake and discharge out of the board:

- Seawater intake.
- Fresh water intake for washing.
- Brine discharge.

4.3.2 Seawater intake

Seacock with through-hull fitting	<p>The ideal seawater intake should be 3/4" minimum and located in a central position, well under the waterline even when the vessel is well heeled over. A scoop skin fitting is recommended. It must be oriented to the bow of the boat.</p> <p>In case of powerboats with a cruising speed above 15 knot it is advised to make a small hole (8 mm. diameter) on the back of the shape, in order to reduce dynamic prevalence during navigation.</p>	<p>Size 3/4"</p>
--	--	------------------

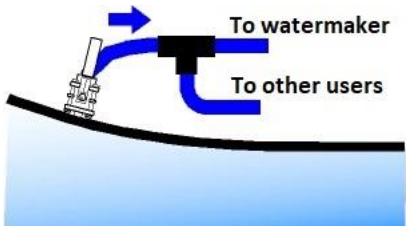
<p>Pre-existing seacock adapting (alternatively)</p>	<p>As alternative, it is possible Tee into a pre-existent water inlet as long as the following conditions are met:</p> <ul style="list-style-type: none"> 3/4" minimum size. The fitting must be located both low and central in the hull and not forward of the keel. No air can be introduced into the system from other use ie: salt water taps in galley. Must always be under the water surface even when the vessel is well heeled over. Must be far from WC discharge. <p> CAUTION Do not use the pre-existing water inlet of the cooling system dedicated to the motor.</p>	<p>Size 3/4"</p> 
---	--	--



INSTALLATION NOTES

- The hose connections, especially if under the seawater level, must be secured with double hose clamps.
- An easily inspected mesh type filter will be required close to the water intake. The filter has to be of 50 Mesh. It is possible to use filters from existing outlets.
- The seawater intake must be at least 3/4" size.



INSTALLATION NOTES

The strainer has to be connected close to the through-hull, and must be easily accessible for inspection.

4.3.3 Fresh water connection for flushing

<p>Fresh water connection for flushing</p>	<p>Tee in downstream the fresh water pressure pump of the boat.</p> <p>The following conditions must be respected:</p> <ul style="list-style-type: none"> • The flow of the fresh water pump must be min 20 lit/min at 1 bar. • Flushing must always be performed with the fresh water pump ON. 	<p>Fresh water pump of the boat: <i>Min. flow rate 20 lit/min. at 1 bar.</i></p>
---	--	---

4.3.4 Brine discharge

<p>Discharge connection</p>	<p>The discharge connection (back to the sea) has to be possibly above the sea level. Minimum size 1/2" BSP</p>	<p>Minimum size 1/2" BSP</p>
	<p>It is possible TEE on existing discharge hoses (for instance tap discharges) provided that there are no returns of dirt water back to the watermaker.</p>	

4.4 Hydraulic connections

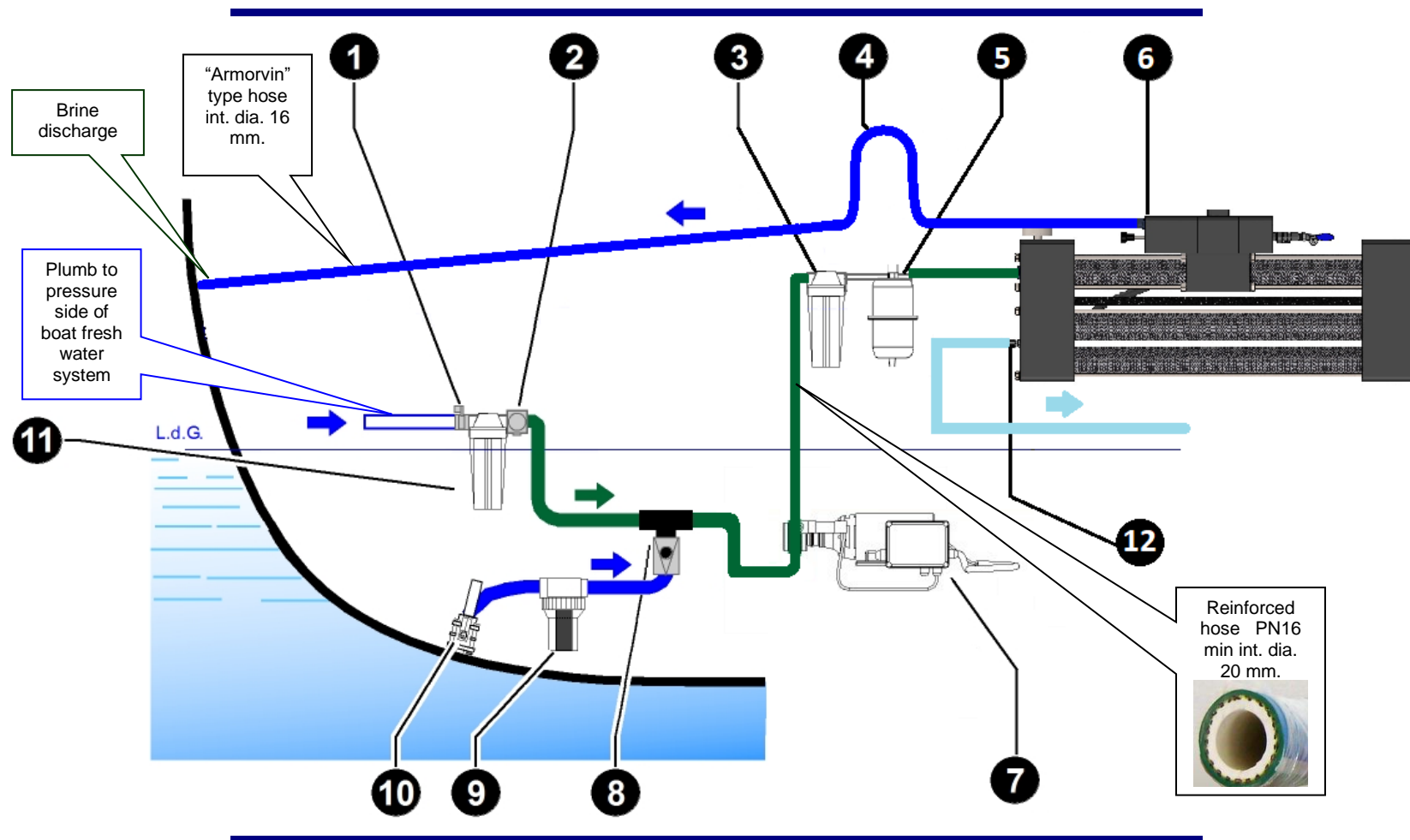

HYDRAULIC CONNECTION AND PIPES
FIG. 4-7

- | | |
|---------------------------------|------------------------|
| ① Pressurized fresh water valve | ⑦ Pump |
| ② Electrovalve | ⑧ Non return valve |
| ③ 5 micron filter | ⑨ Mesh filter |
| ④ Swan neck upward - Discharge | ⑩ Water inlet |
| ⑤ Accumulator | ⑪ Active carbon filter |
| ⑥ Watermaker | ⑫ Fresh water outlet |

All the hydraulic connections (with exception of the fresh water production) have to be made with 16 mm. int. diam. hose. The hydraulic section under consistent pressure is the pump outlet – 5 m. filter – watermaker inlet. For this section is necessary to use a good quality **PN 16 min.** reinforced hose. An inadequate hose could burst, seriously jeopardizing the safety of the vessel.

The hydraulic connections are:

Low pressure connections – max 3 bar	<ul style="list-style-type: none"> • Connection between seawater intake –mesh filter – non-return valve inlet – pump group 	Armorvin reinforced pipe PN 6 with 20mm internal diameter
	<ul style="list-style-type: none"> • Connection between the discharge of the watermaker – through hull discharge fittings of the vessel 	Armorvin reinforced pipe PN6 with 16mm internal diameter
Medium pressure connections – max 10 bar	<ul style="list-style-type: none"> • Connections fresh water pressurized system– carbon filter-backflow valve outlet–pump inlet • Connections pump outlet-5 microns filter– watermaker inlet. 	Rubber reinforced pipe PN 16 minimum, 20 mm internal diameter.
Low pressure connections – max 3 bar	<ul style="list-style-type: none"> • Watermaker - fresh water tank 	¼” fittings, Small plastic blue pipe 6x8mm provided within the scope of supply



PUMP CONNECTIONS:

Connect the in/out hose to the pump as follows:

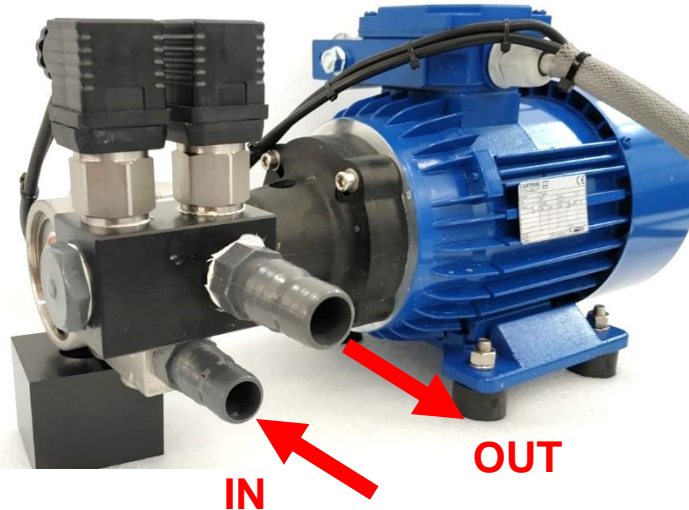

PUMP IN AND OUT
FIG. 4-8



CAUTION

The pump has to be placed as close as possible to the seawater intake and as low as possible respect to the seawater level; furthermore, it is recommended to avoid long and convoluted path of the connection hoses.



ATTENTION

The use of improper hoses can cause them to burst which endangers the security of the vessel.

WATERMAKER CONNECTIONS:

WATERMAKER INLET (Sea water inlet from the pump):

Make use of the holder located on the right side of the watermaker (marked **IN**).

WATERMAKER OUTLET (Discharge outboard):

Make use, for this connection, of the holder located on right of the unit (marked **OUT**). Create a Swan neck upward, when the drain outlet on the vessel is positioned below the watermaker unit, in order to guarantee a water head.

PRODUCTION FRESH WATER CONNECTION

The connection has to be made using the small hose supplied with the equipment. The connection has to be made between the polyethylene pipe that comes out the watermaker unit (on the right), and the upper side of the tank, on a 1/4" outlet if available.

It is possible, in case of metal tanks, to make a 1/4" threaded hole to connect the supplied male connector. Another option is to Tee into the tank air vent hose. There are no particular limits on the connection length.

4.5 Electric connections



ATTENTION

These steps have to be performed by a qualified technician/operator, by referring to the electrical drawings provided within this document.

4.5.1 Remote control panel mounting

The remote control panel has the following dimensions:

width 100 mm. height 66 mm.

It can be fixed on any internal boat panel, provided that the area behind is free of humidity and condensation and there is enough depth to house the rear part of the panel (approx. 50 mm.).

The cut to be performed on the boat covering panel, to encase the remote control panel, has the following dimensions:

width 80 mm. height 50 mm.

The remote control panel can be connected through the pre-wired multiple cable of a 10mt standard length provided. It is possible to require to the factory a longer cable if necessary.



REMOTE CONTROL PANEL
fig. 4-9

4.5.2 Electric connections: wires (ZEN 100 12/24V DC)

The electric connectors are positioned inside the small electric box connected to the computer box. The power supply, coming from the service batteries, needs to be connected to the terminals – and + . The connection to the vessel panel needs to be performed downstream the voltmeter and the ammeter of the vessel panelboard. The connecting terminal must be suitable to support the plant electric load (approx. 500 Watt). A 63 Ampere automatic circuit breaker for 12V DC systems must be installed on the power supply, while a 32 Ampere for 24VDC systems.

The general wires connection scheme (between the external devices and the main electric box) is the following:

Voltage	Automatic switch	Cable lenght					
		up to 3 mts		3 - 7 mt.		7-10 mt.	
Volt	Ampere	mm2	AWG	mm2	AWG	mm2	AWG
12	63	16	5	25	3	25	3
24	32	10	7	10	7	10	7

The manual microswitches allow to turn on the pump and the electrovalve. They can be used to turn on the watermaker in emergency. They have to be on the OFF position during the normal functioning condition. The overload current of the fuse is 400mA.

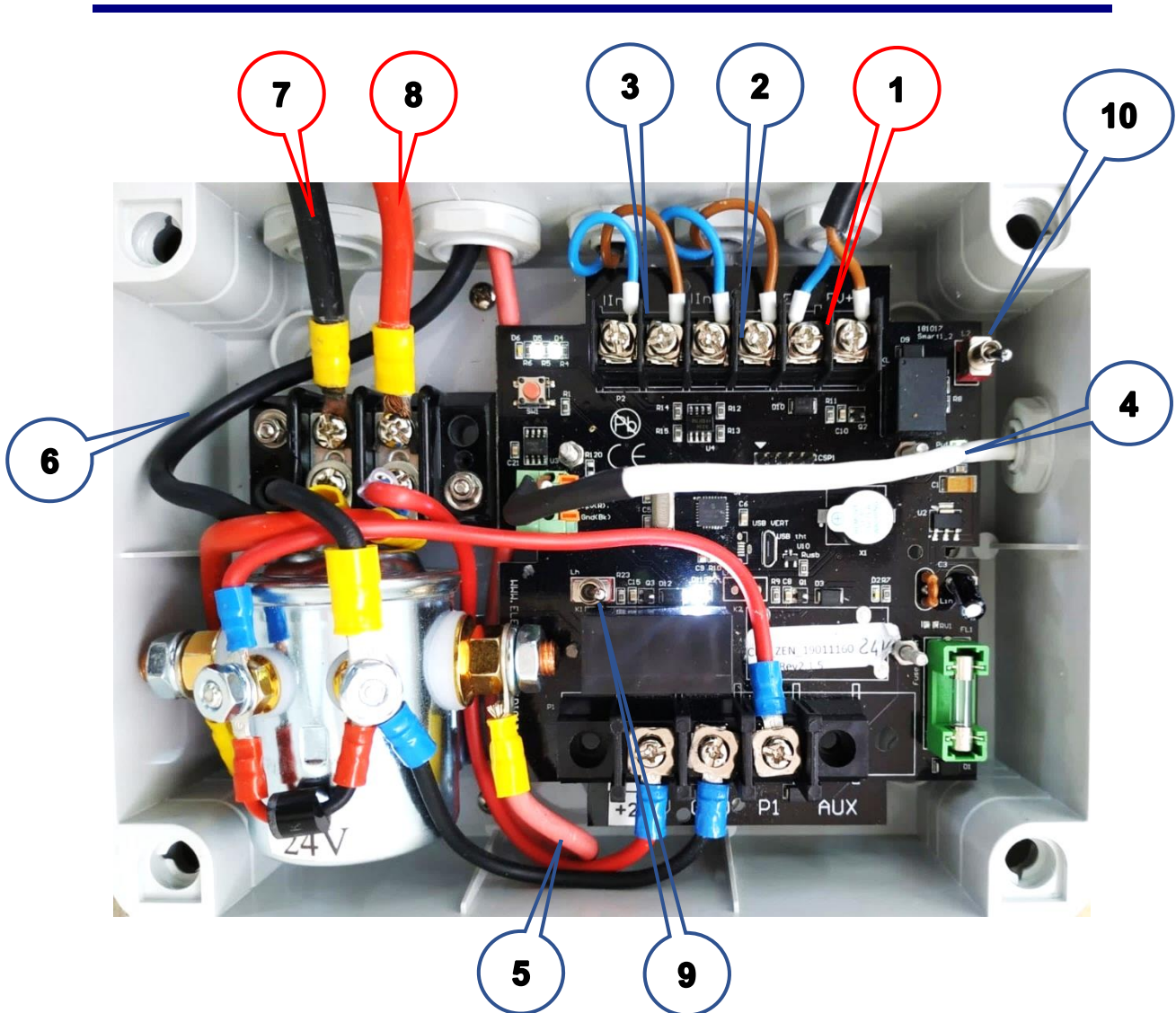

CENTRAL BOX ZEN 100 12/24V DC
FIG. 4-10

IN RED: CONNECTIONS TO BE MADE DURING THE INSTALLATION

- | | |
|------------------------------|--------------------|
| ① Electrovalve (EV) | ⑥ Pump negative |
| ② Pressure switch pump | ⑦ Battery negative |
| ③ Pressure switch pump | ⑧ Battery positive |
| ④ Connection to remote panel | ⑨ Pump microswitch |
| ⑤ Pump positive | ⑩ EV microswitch |

5. FUNCTIONING AND USE

5.1 Command description



REMOTE CONTROL PANEL
Fig. 5.1

KEYBOARD FEATURES

The panel keyboard has a total of 2 switch buttons. The functions of the buttons are:

ON/OFF Used to start and stop the pumps of the system.

FLUSHING Used to activate the electrovalve and let the system rinse with fresh water.

5.1.1 Alarms description

The system has three different types of alarm, recognizable by the flashing of the two LEDs on the pushing buttons. If the alarms occur the controller immediately stops the unit:

- **Unit stalled:** the pressure is under the threshold value during the start – the system goes on alert after 5 seconds and the pushing buttons flash 2 times quickly;
- **Underpressure:** the pressure drops under the threshold value during the functioning – the system goes on alert and the pushing buttons flash 3 times quickly.
- **Overpressure:** the pressure raises over the threshold value during the functioning – the system goes immediately on alert and the pushing buttons flash 4 times quickly.

In all three cases the alarm has to be stopped by pressing the button ON/OFF; then it is necessary to recognize and eliminate the problem before starting again the watermaker.

5.2 First start-up procedure

The first start up procedure is necessary to start a new system or after a filter replacement or a chemical washing.



The start-up procedure is mainly aimed to purge the air separately from the unit and the 2 pumps.



5.2.1 Preliminary checks before proceeding with the start-up procedure

Perform the following checks before proceeding with the start-up procedure:

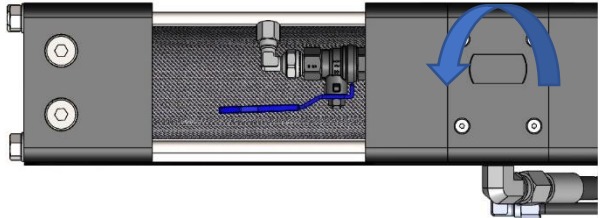
1. Verify all components and hoses are connected correctly.
2. Verify the 5 micron and active carbon cartridges are installed.
3. Check the seawater inlet valve and salt water drain valve (if existing) are open.
4. Check the reset valve is closed (lever orthogonal to the body valve) and the positioner completely unscrewed.
5. Check the fresh water pressurizing pump of the boat is on.
6. Check the grey valve on the active carbon filter is open.

5.2.2 Start-up

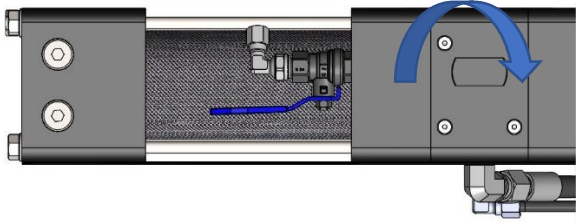
<p>1. Open the depressurization valve (unscrew the valve).</p>	
<p>2. Push Flushing for 5 seconds. The panel emits 2 beeps, the push buttons blinks quickly, and the sequence for purging starts. After about 3 minutes the sequence will finish. The sequence can be stopped at any time pushing ON/OFF.</p>	
<p>3. Start the unit again pushing ON/OFF.</p>	

<p>4. Close the depressurization valve. The system starts going under pressure and the fresh water production begins. Check the working pressure of the unit is correct (7-8 bar).</p>	
<p>5. After a while push FLUSHING in order to flush the unit before stopping it. Then the unit will stop after about 1 minute.</p>	

After completed the procedure the system is ready to start normally.

5.3 Normal operating procedure

Preliminary checks:

1. Reset valve closed (lever orthogonal to the body valve) and the positioner completely unscrewed.
2. Depressurization valve closed and grey valve on the active carbon filter open.

5.3.1 Normal operating procedure without final flushing

<ol style="list-style-type: none"> 1. Push ON/OFF to start the watermaker. 2. Push ON/OFF to stop the watermaker. 	
---	--

5.3.2 Normal operating procedure with final flushing (recommended procedure)

1. Push ON/OFF to start the watermaker.
2. Push FLUSHING to flush and stop the watermaker. The watermaker will activate a flushing cycle then it will stop itself after 1 minute



5.3.3 Working cycle with timer

1. Keep ON/OFF pressed for a while, then you will hear 1-2-3-beeps. Once released ON/OFF the watermaker will work for 1-2-3 hours then will flush and will stop.
2. The unit can be stopped at any time by pushing the ON/OFF button (without final flushing) or the FLUSHING button (with final flushing).



5.3.4 Long flushing procedure

1. Push FLUSHING. A 3-minute flushing procedure with fresh water will start. Both ON/OFF and FLUSHING buttons' lights will be on.
2. The unit can be stopped at any time by pushing the ON/OFF button



5.4 Reset procedure

If the watermaker sucks air (or if other problems occur), the automatic hydraulic valve may stop in a central position.

In this case, when the unit is started, it gets suddenly high pressure without cycling. After few seconds the computer recognizes the problem and turn off the pump.

In this case the system has to be manually reset.

This event, besides being very unusual, does not damage the system, but it is necessary to reset the valve with the following simple procedure:

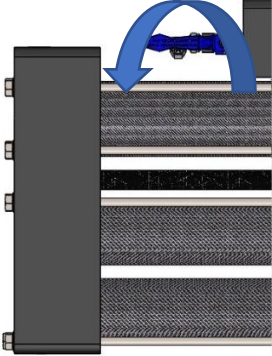
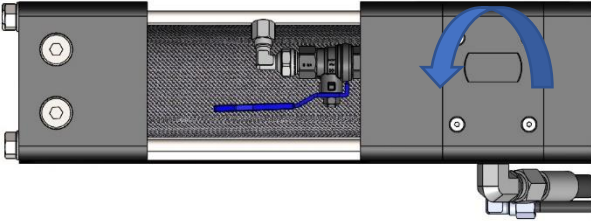
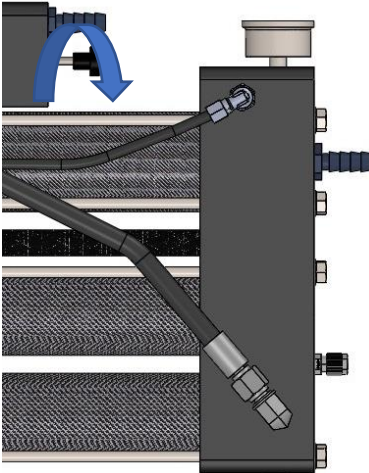
<p>1. Open the reset valve (lever in horizontal position).</p>	
<p>2. Open slightly the depressurization valve.</p>	
<p>3. Screw the positioner knob clockwise until it can be moved no further. Normally 18 complete turns at least are needed.</p>	

4. Unscrew the positioner knob counterclockwise back to its original position, until it can be turned no more.

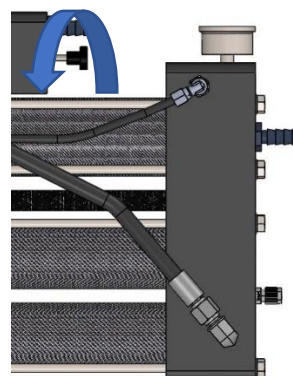

5. Close the reset valve (lever in vertical position).

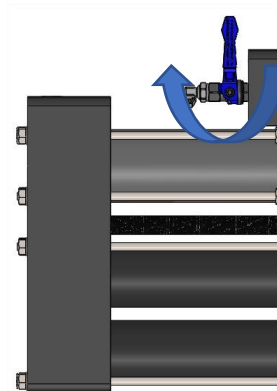

6. Restart the system.



7. After some seconds close the depressurization valve.

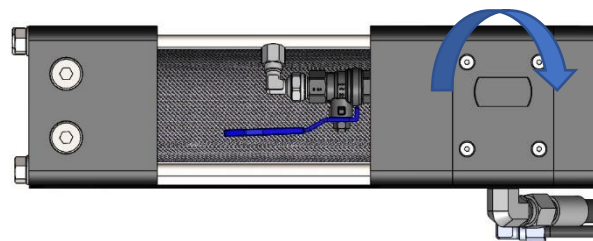



6. MAINTENANCE (ROUTINE AND SPECIAL)

6.1 Check filter cleanliness

It is very important to inspect filters condition periodically.
The following filters are present in the system:

1. Strainer
2. Pump filter (5 micron cartridge filter).
3. Active carbon filter.

OPERATION	FREQUENCY	PROCEDURE
Check and clean the strainer	Every 5 days	<p>Visual inspection and washing</p> 
Replacing of the 5 micron cartridge filters	It depends on the real working condition and the turbidity of the sea water. In average conditions the replacement of the cartridge is recommended every 100-120 working hours. Once replaced the filters it is necessary to purge the air from the system, opening for 2-3 minutes the depressurization valve.	<p>Unscrew the filter housing counter clockwise by using the specific key provided</p> 
Replace the active carbon fibre filter	Once per year	<p>Unscrew the filter housing counter clockwise by using the specific key provided</p> 

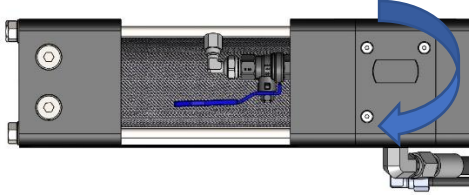
<p>Purge air from the system periodically by opening for 2-3 minutes the depressurization valve slightly.</p>	<p>Every 15-20 days</p>	
---	-------------------------	--

6.2 Check the plant working pressure

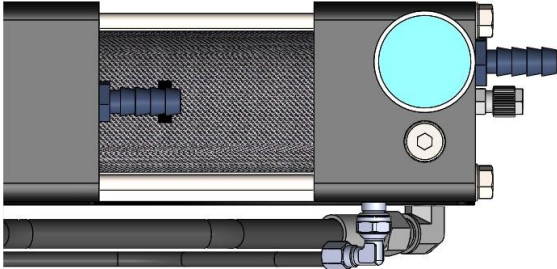
<p>The working pressure of the pump is indicated on the manometer of the main unit. The working pressure depends on many factors such as water temperature, seawater salinity, batteries voltage, membranes conditions, typology of installation. The pressure, in normal working conditions, is in the range 7-8 bar. There is periodic small pressure peak (during commutation) of 0,2 bar.</p>	
---	---

If the average pressure exceeds the above range it is necessary to check the membranes cleanliness. If the pressure is above the mentioned range probably the membranes are dirty or clogged, and it is necessary to perform a cleaning with the chemical SC1. If the cleaning with SC1 is not enough to reduce the pressure, it could be necessary an alkaline washing with the cleaning SC2.

6.3 Check for leaks

It is necessary to perform this verification at every plant start-up and frequently, as possible leaks due to accidental causes (hose bursting, hose clamp loosening, equipment failure, etc.) may occur with the consequence of the possible damage.

6.4 Check for membranes replacement

The reverse osmosis membranes last on average 6-7 years. When the membranes are old usually the quality of water decreases and/or the working pressure increases. If chemical washings don't produce significant improvements, it is recommended to replace the membranes.

6.5 Shutdown procedure

It is necessary to perform the shutdown procedure before standstills longer than 2-3 months, for instance before the winter laying up.

The purpose of the shutdown is to flush the system from possible organic and inorganic sediments, and inhibit the growth of bacteria that could reduce the reverse osmosis membranes efficiency.

6.5.1 Necessary Equipment

The following equipment is necessary to perform the shutdown operation:

1. 1 tank of fill with at least 15 litres of fresh
2. 3 hoses to be connected to:
 - inlet of the pump
 - discharge of the watermaker
 - fresh water out
3. A bottle of powder **SCHENKER CLEANING 1 (SC1)**. The solution must be prepared following the instruction indicated on the bottle label, and **using unchlorinated water** (for instance water produced by the system can be an option).
4. Tools for dismounting the system's pipes (screwdrivers, pliers, etc.)

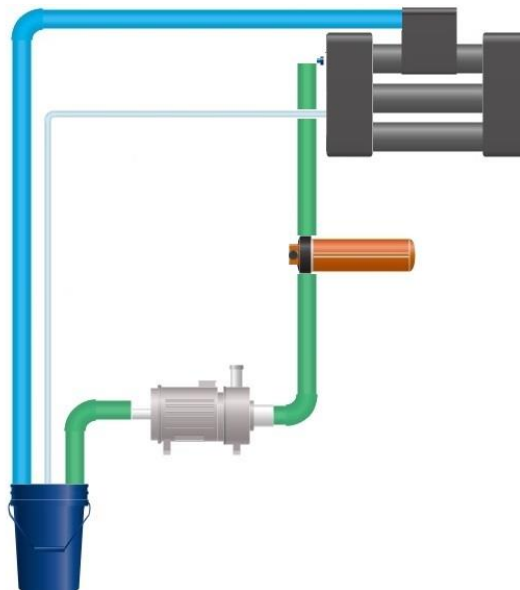

HYDRAULIC SCHEME FOR SHUTDOWN PROCEDURE
FIG. 6-1



NOTE

The available products for the shutdown procedure are the following:

1) SCHENKER CLEANING 1 (SC1 – Acid product) to remove the inorganic components and preserve the watermaker during winter break.

2) SCHENKER CLEANING 2 (SC2 – Alkaline product) to remove the organic components (mould and bacteria) when already deposited; in this case the system and/or the water produce a “bad eggs” smell. Allow a period of 20 mins for both acid & alkaline cleaning.

It is important that the depressurizing knob is partially opened when this is procedure is carried out.



NOTE

Normally only SC1 is required, but in case of strong bad smell (organic contamination) it is recommended to use SC2 as well.



The sequence in this case will be SC2 first, then a flushing of the unit with fresh water, and finally the SC1. Leave the product in the system to winterize the unit.

It is advisable to replace the filters after performed the cleaning procedure with new ones.

If the unit will not be used for a long period (in example before winter) the filters can also be removed.

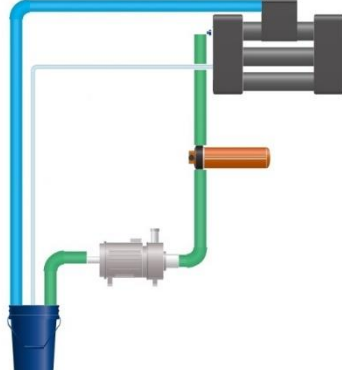
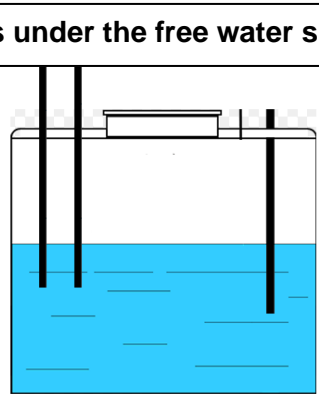
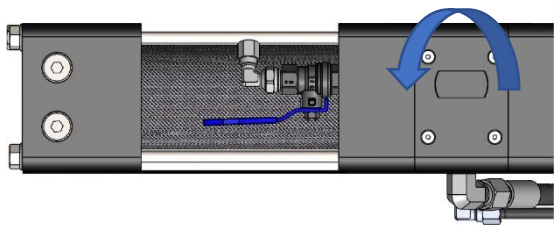
6.5.2 Shutdown operating procedure

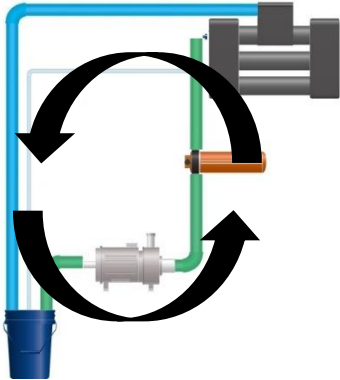
<p>1. Prepare the solution carefully mixing the bottle of SC1(or SC2) in about 15 litres of unchlorinated water.</p>	
<p>2. Connect the 3 hoses to the pump and watermaker as indicated above, and dip them in the solution.</p>	
<p>3. Check they are well submerged in the solution and don't suck air.</p>	<p style="text-align: center;">Pipes under the free water surface</p> 
<p>4. Open the depressurization valve.</p>	

<p>5. Start the watermaker.</p>	 A black rectangular control panel with the 'Schenker' logo at the top. It features two circular buttons. The left button is labeled 'ON / OFF' and has a blue arrow pointing to it from the left. The right button is labeled 'FLUSHING'.
<p>6. Leave the unit running for approx. 20 minutes, checking that the hoses are properly positioned in the recipient, so that to avoid inhaling air.</p>	 A schematic diagram of the watermaker unit. It shows a blue bucket connected to a blue hose that leads to a pump. From the pump, a green hose goes to a vertical pipe with a valve. A black circular arrow indicates a clockwise flow path from the bucket, through the pump, and back to the bucket.
<p>7. Stop the unit and connect the original hoses.</p>	 A black rectangular control panel with the 'Schenker' logo at the top. It features two circular buttons. The left button is labeled 'ON / OFF' and has a blue arrow pointing to it from the left. The right button is labeled 'FLUSHING'.



CAUTION

It is necessary to perform the first start-up procedure when restarting the plant after a shutdown procedure, in order to purge the air and drain out chemicals in the systems.

6.6 Antifreeze procedure (Winterizing procedure in cold climate - under 5°C)

It is recommended to first perform the normal shutdown procedure by using SC1 in order to clean the system properly and prevent bacteria growth and inorganic material deposit.

After this operation, Then the system must be flushed and filled with an antifreeze.

The recommended antifreeze product is a solution of **propylene glycol and unchlorinated water**.

The ideal concentration of propylene glycol is

- 45% (for temperatures up to - 20°)
- 55% (for temperatures up to - 30°).



ATTENTION

Do not use ethylene glycol as this substance is toxic and non-degradable.

The total volume of the solution must be about 15 litres.

The procedure is similar to that used for chemical washing with SC1 and SC2 products:

1. Prepare the solution carefully mixing the propylene glycol with 15 litres of unchlorinated water by following the concentration suggested above.
2. Disconnect the drain hose and the pumps suction hose.
3. Connect two hose pieces to the drain and to the pump suction.
4. Insert the end side of the hoses into the bucket, verifying that the hoses have been properly dipped in the solution and that they don't inhale air.
5. Open the depressurization valve.
6. Start the watermaker.
7. Leave the unit running for approx. 5 minutes.
8. Stop the unit and connect the original hoses. The antifreeze solution must stay in the system. Take care to not empty the system when reconnecting the hoses.

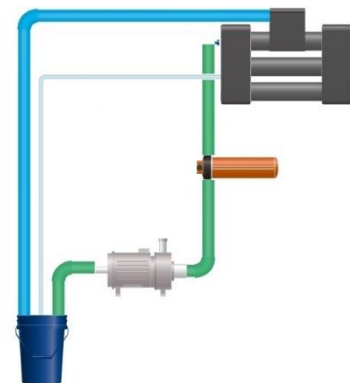

HYDRAULIC SCHEME FOR WINTERIZING PROCEDURE
FIG. 6-2



ATTENTION

Before proceeding with any kind of service it is strongly recommended to read carefully the instructions contained in this manual.

6.7 Periodic maintenance

6.7.1 Membrane replacement

The reverse osmosis membranes last on average 6-7 years. When the membranes are old usually the quality of water decrease and/or the working pressure increases. If chemical washings don't produce significant improvements, it is recommended to replace the membranes.

6.8 Adjustments

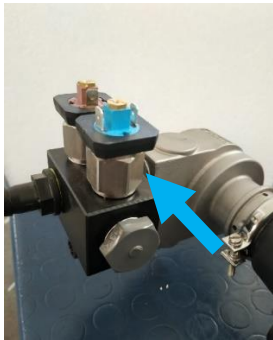
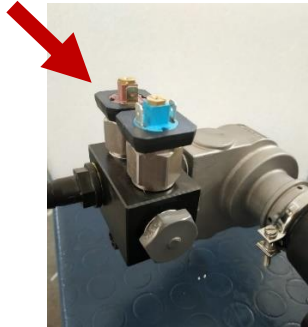
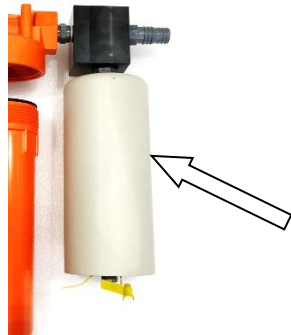
<p>Pump high pressure switch</p> <p>The main pump is equipped with a high pressure switch set at around 13 Bar. The pressure switch can be calibrated with a screwdriver. To calibrate the pressure switch pull out the plug, remove the security nut, and engage the small internal screw with a small screw driver. Turning clockwise the calibration of the pressure switch increases, while turning anticlockwise the calibration decreases.</p>	
<p>Pump low pressure switch</p> <p>The main pump is equipped with a low pressure switch set at around 1,3 Bar. The pressure switch can be calibrated with a screwdriver. To calibrate the pressure switch pull out the plug, remove the security nut, and engage the small internal screw with a small screw driver. Turning clockwise the calibration of the pressure switch increases, while turning anticlockwise the calibration decreases.</p>	
<p>Accumulator</p> <p>It is a polypropylene reservoir of air that has the function of damping the pressure oscillations during the commutations of the watermaker. The accumulator is factory loaded at a pressure of about 6 bar. The charge level must be periodically checked in order to guarantee a correct functioning to the watermaker.</p>	

7. TROUBLESHOOTING

7.1 Troubleshooting chart

Issue	Probable cause	Remedy
Pump doesn't start	Pump pressure switch disconnected or burned Electronic failure	Restore or replace the pump pressure switch Start pump and electrovalve using microswitches.
Pump starts but the system suddenly blocks in high pressure	Hydraulic block Dirty filters	Perform reset procedure Replace filters
During operation, the pump temporarily switches off, giving rise to a start and stop phenomenon	Pump pressure switch not correctly set Dirty filters or membranes	Calibrate pump pressure switch Clean or replace
High pressure variations during commutation (> 0,4 Bar)	Low accumulator pressure low	Inflate at a pressure of 6 Bar
Low production / normal or low pressure	Low battery Air within the system	Check battery charge Purge air opening for a while the pressure valve
Low production / high pressure (> 10 Bar)	Clogged filters Clogged membranes Cold seawater	Replace filters Perform washing with SC1 Normal condition

8. SUGGESTED SPARE PARTS

8.1 Short term cruising

For short term cruising it is advisable to have onboard a cleaning kit (one SC1 and one SC2 cleaning product) as well as one 5 microns cartridge filter. Other additional spare parts are listed below with their codes:

Spare part name	Code
SC1 WASHING PRODUCT	SC1
SC2 WASHING PRODUCT	SC2
CLEANING KIT (SC1+SC2)	CK
5 MICRON CARTRIDGE 5	F5
ACTIVE CARBON FILTER CARTRIDGE	CA

8.2 Long term cruising

For long term cruising it is advisable to have onboard a cruising kit (three x 5 microns cartridge filter, one active carbon filter, one cleaning kit) and a pump pressure switch. Other additional spare parts are listed below with their codes:

Spare part name	Code
SC1 WASHING PRODUCT	SC1
SC2 WASHING PRODUCT	SC2
CRUISING KIT	CRK136
PUMP HEAD 100/150 L	SP10
PUMP MOTOR 80/100 12V	MP10/12
PUMP MOTOR 80/100 24V	MP10/24
MEMBRANE 4021	M4021
PORTABLE SALINITY TESTER	PST
PUMP HIGH PRESSURE SWITCH 80/100	PSP10
PUMP LOW PRESSURE SWITCH 80/100	PSSS361
SPARE SEALS KIT ZEN100	SSZ1